

20 26

**Catalogue
Export_01**

**Supports for
outdoor raised floors**



INDEX



PP LEVEL DUO MAXI _____ pag 4



PP LEVEL MAXI FIX _____ pag 14



PP LEVEL MINI _____ pag 20



PP LEVEL SP _____ pag 21

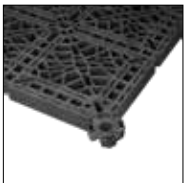

PP LEVEL GRID _____ pag 22



COMPLEMENTARY PRODUCTS _____ pag 26



POS MATERIAL _____ pag 34

INDEX BY ITEM _____ pag 36





**PP level DUO
MAXI**

supports for outdoor raised floors

PP level DUO MAXI

PPlevel**DUO****MAXI**



THE SYSTEM FOR THE INSTALLATION OF OUTDOOR RAISED FLOORS, MAXI IN EVERYTHING



PP level DUO MAXI is a range of adjustable supports for outdoor raised floors designed and produced by Profilpas. **MAXI flexibility:** thanks to the practical Fixed Head Ring, you can transform the self-levelling head, able to compensate for surface slopes up to 5%, into fixed head, directly during the installation. **MAXI strength:** the support guarantees excellent resistance to heavy loads and weather elements. **MAXI versatility:** numerous accessories are available for any installation requirement, from extensions to aluminium joists, rubber mats and steel clips. With PP level DUO MAXI the installation of the outdoor raised floor will be easy, fast and perfect.





SELF-LEVELLING OR FIXED HEAD

According to the conformation of the subfloor and the needs that may arise during the installation, with PP level DUO MAXI you can choose between **self-levelling head**, which allows you to compensate for slopes up to 5%, or **fixed head** directly during the installation. To obtain a fixed head support, simply insert the practical **Fixed Head Ring**, already integrated into the base and ready to use, between the head and the screw.

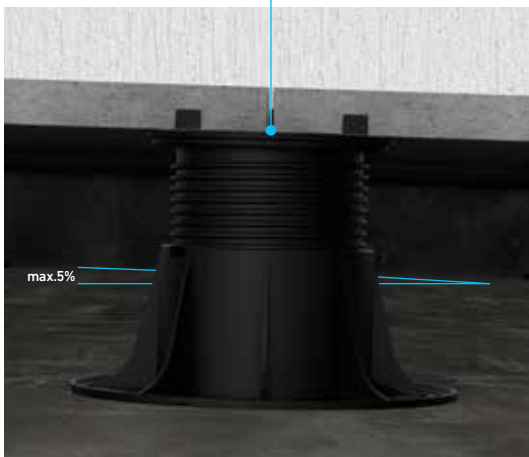

FIXED HEAD SUPPORT

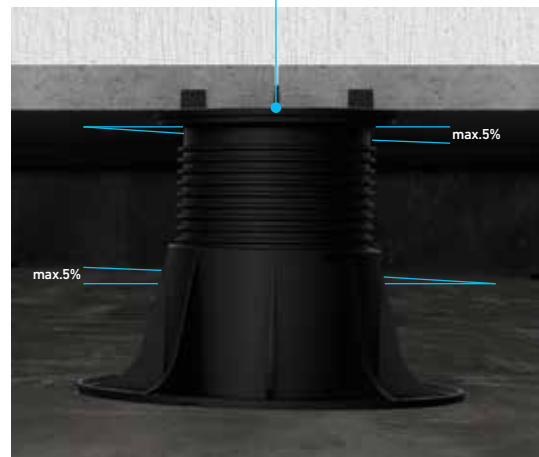

SELF-LEVELLING HEAD SUPPORT

CHARACTERISTICS AND ADVANTAGES

Outdoor raised floors are the ideal solution for building renovations and new buildings. Their advantages are many: they are **simple and quick to install** and just as **quick to remove** for any maintenance of cables and pipes or to inspect the waterproofing layer. Moreover, they **absorb expansions** and structural movements, thus preventing cracks and breaks, and **facilitate air recirculation** between the floor and the surface on which the supports are placed.



VERSATILITY OF THE RANGE

The range, composed of **five different sizes of supports, three heads, and an extension**, meets any height requirement for installing self-supporting slabs in ceramic, natural stone, or concrete, as well as decking surfaces.



WATER DISPOSAL

A **system of drainage** holes at the head connection and at the support base prevents the stagnation of rainwater, ensuring its effective disposal.



EASY AND MILLIMETRIC ADJUSTMENT

The support height can be adjusted to the millimetre, even when the floor has already been laid, using the provided adjustment **key**, so that to obtain perfectly level floors without wasting time.



SPEED AND EASE OF INSTALLATION

The support is **simple and quick to assemble**. Likewise, the installation of the raised floor is fast and easy, thanks to the height adjustment from above.



MAXIMUM DURABILITY

PP level DUO MAXI supports have a high mechanical resistance to compression and are **resistant to the most extreme climatic conditions** (UV, weathering elements, temperatures from -40°C to +75°C).



TOTALLY RECYCLABLE

All elements that make up PP level DUO MAXI are made of **polypropylene and thermoplastic rubber**.



THE RANGE



S/28/39B
h. 28-39 mm



M/38/57B
h. 38-57 mm



L/56/91B
h. 56-91 mm



XL/87/150B
h. 87-150 mm



XXL/148/211B
h. 148-211 mm



P1/80TE
Extension h. 80 mm

PP LEVEL DUO MAXI + P1/80TE EXTENSION

P1/80TE	+1	+2	+3	+4	+5
XL/87/150B	167/254				
XXL/148/211B	228/315	308/419	388/523	468/627	548/732
P1/80TE	+6	+7	+8	+9	+10
XL/87/150B					
XXL/148/211B	628/836	708/940	788/1044	868/1148	948/1253

measures indicate H min / H max

SUPPORTS FOR ANY INSTALLATION REQUIREMENT

With PP level DUO MAXI, Profilpas wants to offer an **integrated system of solutions** to compensate for small and large slopes, up to 5%, and obtain perfectly stable and level raised surfaces of any height. A complete range, able to satisfy any installation requirement, which can be used with **different self-supporting coverings**, such as ceramic tiles, single- and multi-format ceramic planks, wooden coverings, decking or other materials.



PPLM/T2
PPLM/T3
PPLM/T4

SELF-LEVELLING HEAD FOR CERAMIC FLOORS

Head to be used for the **installation of ceramic floors**, equipped with easily removable tabs for 2, 3 and 4 mm joints and noise-proof, antislip, heat-sealed rubber for a greater acoustic comfort and maximum stability.



PPLM/TA

CRISSCROSS HEAD FOR ALUMINIUM JOISTS

Crisscross head to be used with special aluminium joists, for the **installation of raised floors with single- and multi-format ceramic planks**. With these joists, equipped with a rail for positioning the spacers and available also in **draining version**, it is possible to create a substructure that increases stability and load-bearing capacity. When turned upside down, the joist can also be used for installing **decking floors**.



PPLM/TD

UNIVERSAL L-HEAD FOR JOISTS

Universal L-head for screw fixing of all types of joists for the **installation of decking floors**.



- 1 PP level DUO MAXI with self-levelling head PPLM/T2-3-4 for the installation of ceramic floors.
- 2 PP level DUO MAXI system with crisscross head PPLM/TA and aluminium joists PPL/T1 for the installation of single- and multifformat ceramic planks.
- 3 PP level DUO MAXI system with crisscross head PPLM/TA and aluminium crosswise joists PPL/T1 for greater stability at heights above 40 cm.
- 4 PP level DUO MAXI system with crisscross head PPLM/TA and rotated aluminium joists PPL/T1 for the installation of decking floors.
- 5 PP level DUO MAXI system with L-head PPLM/TD for the installation of decking floors with joists PPL/5030/T.

PP level DUO MAXI



S/28/39/4



M/38/57/4



L/56/91/4



XL/87/150/4



XXL/148/211/4



S/28/39B



M/38/57B



L/56/91B



XL/87/150B



XXL/148/211B



P1/10



P1/80TE

PP LEVEL DUO MAXI - BASE + SCREW + HEAD 4 MM

ART.		Cod.	Pack	Pallet
S/28/39/4	base + screw + head 4 mm adjustable from h. 28 to 39 mm	19270	24 pcs	1152 pcs
	<i>euro/pc (euro/pack)</i>			
M/38/57/4	base + screw + head 4 mm adjustable from h. 38 to 57 mm	19271	24 pcs	960 pcs
	<i>euro/pc (euro/pack)</i>			
L/56/91/4	base + screw + head 4 mm adjustable from h. 56 to 91 mm	19272	24 pcs	672 pcs
	<i>euro/pc (euro/pack)</i>			
XL/87/150/4	base + screw + head 4 mm adjustable from h. 87 to 150 mm	19273	24 pcs	480 pcs
	<i>euro/pc (euro/pack)</i>			
XXL/148/211/4	base + screw + head 4 mm adjustable from h. 148 to 211 mm	19279	12 pcs	240 pcs
	<i>euro/pc (euro/pack)</i>			

no partial packaging

PP LEVEL DUO MAXI - BASE + SCREW

ART.		Cod.	Pack	Pallet
S/28/39B	base + screw adjustable from h. 28 to 39 mm	19250	24 pcs	1152 pcs
	<i>euro/pc (euro/pack)</i>			
M/38/57B	base + screw adjustable from h. 38 to 57 mm	19251	24 pcs	1152 pcs
	<i>euro/pc (euro/pack)</i>			
L/56/91B	base + screw adjustable from h. 56 to 91 mm	19252	24 pcs	672 pcs
	<i>euro/pc (euro/pack)</i>			
XL/87/150B	base + screw adjustable from h. 87 to 150 mm	19253	24 pcs	480 pcs
	<i>euro/pc (euro/pack)</i>			
XXL/148/211B	base + screw adjustable from h. 148 to 211 mm	19278	12 pcs	240 pcs
	<i>euro/pc (euro/pack)</i>			

no partial packaging

EXTENSIONS FOR PP LEVEL DUO MAXI

ART.		Cod.	Pack	Pallet
P1/10	extension h. 10 mm	19369	15 pcs	1800 pcs
	<i>euro/pc (euro/pack)</i>			
P1/80TE	extension h. 80 mm	19254	24 pcs	960 pcs
	<i>euro/pc (euro/pack)</i>			

no partial packaging

XL/87/150B+P1/80TE	=	167 / 254 mm	XXL/148/211B+(6xP1/80TE)	=	628 / 836 mm
XXL/148/211B+P1/80TE	=	228 / 315 mm	XXL/148/211B+(7xP1/80TE)	=	708 / 940 mm
XXL/148/211B+(2xP1/80TE)	=	308 / 419 mm	XXL/148/211B+(8xP1/80TE)	=	788 / 1044 mm
XXL/148/211B+(3xP1/80TE)	=	388 / 523 mm	XXL/148/211B+(9xP1/80TE)	=	868 / 1148 mm
XXL/148/211B+(4xP1/80TE)	=	468 / 627 mm	XXL/148/211B+(10xP1/80TE)	=	948 / 1253 mm
XXL/148/211B+(5xP1/80TE)	=	548 / 732 mm			

For heights exceeding 20 cm, we recommend using an additional central support.

For heights exceeding 40 cm, we recommend using the PP LEVEL DUO MAXI-JOIST system or installing the PP LEVEL GRID anti-breakage system.



PPLM/T2
PPLM/T3
PPLM/T4



PPLM/TA



PPL/T1



PPL/TH



PPL/D4

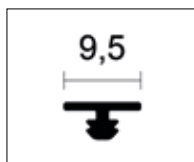

PPL/GM50
PPL/GM200



PPL/GR1



PCC/L



PPLM/TD



PPL/5030/T



PP Level DUO MAXI
Joist



PP Level DUO MAXI
Drainage Joist



PP Level DUO MAXI
Decking

PP LEVEL DUO MAXI - SELF-LEVELLING HEAD FOR CERAMIC FLOORS

ART.		Cod.	Pack	Pallet
PPLM/T2	head for 2-mm joints <i>euro/pc (euro/pack)</i>	19255	48 pcs	3840 pcs
PPLM/T3	head for 3-mm joints <i>euro/pc (euro/pack)</i>	19256	48 pcs	3840 pcs
PPLM/T4	head for 4-mm joints <i>euro/pc (euro/pack)</i>	19257	48 pcs	3840 pcs

no partial packaging

PP LEVEL DUO MAXI - JOIST

ART.		Cod.	Pack	Pallet
PPLM/TA	head for aluminium joist <i>euro/pc (euro/pack)</i>	19259	48 pcs	3840 pcs
PPL/T1	natural aluminium joist 60,3x24 mm - L 240 cm <i>euro/m (euro/pack)</i>	19260	8 pcs	
PPL/TH	nat. aluminium drainage joist 60,3x24 mm - L 240 cm <i>euro/m (euro/pack)</i>	19262	8 pcs	
PPL/D4	4-mm spacer for joist <i>euro/pc (euro/pack)</i>	19398	500 pcs	
PPL/GM50	noise-proof gasket for joist - 50 meters roll <i>euro/m (euro/pack)</i>	19263	1 pc	
PPL/GM200	noise-proof gasket for joist - 200 meters roll <i>euro/m (euro/pack)</i>	19264	1 pc	
PPL/GR1	connection joint for joist <i>euro/pc (euro/pack)</i>	19265	250 pcs	
PCC/L	wall fixing bracket for PPL/T1 joist <i>euro/pc (euro/pack)</i>	19367	20 pcs	

no partial packaging

PP LEVEL DUO MAXI - DECKING

ART.		Cod.	Pack	Pallet
PPLM/TD	head for decking <i>euro/pc (euro/pack)</i>	19258	48 pcs	3840 pcs
PPL/5030/T	natural aluminium joist for decking - section 50x30 mm - length 200 cm <i>euro/m (euro/pack)</i>	19389	8 pcs	160 pcs
PPL/TD/GR	connection joint for decking joist <i>euro/pc (euro/pack)</i>	19387	12 pcs	
PPL/TD/TT	T connection joint for decking joist <i>euro/pc (euro/pack)</i>	19388	20 pcs	

no partial packaging



PPL/TD/GR



PPL/TD/TT





**PP level
MAXI FIX**

PP level MAXI FIX

PP LEVEL MAXI FIX, ADJUSTABLE FIXED-HEAD SUPPORTS



PP level MAXI FIX is a line of **adjustable, fixed-head supports** for self-supporting outdoor raised floors. Available for heights from 25 to 208 mm, PP level MAXI FIX supports can be adjusted in height from above through the adjustment key and have a head with tabs for 4-mm joints. They are suitable when the floor covering must be parallel to the surface on which the support lays.





S/25/36/4F



M/35/54/4F



L/53/88/4F



XL/84/147/4F



XXL/145/208/4F



S/28/39B



M/38/57B



L/56/91B



XL/87/150B



XXL/148/211B



PP LEVEL MAXI FIX - BASE + SCREW + FIXED HEAD 4 MM

ART.		Cod.	Pack	Pallet
S/25/36/4F	base+screw+fixed head 4 mm adjust. from h. 25 to 36 mm <i>euro/pc (euro/pack)</i>	19274	24 pcs	1152 pcs
M/35/54/4F	base+screw+fixed head 4 mm adjust. from h. 35 to 54 mm <i>euro/pc (euro/pack)</i>	19275	24 pcs	960 pcs
L/53/88/4F	base+screw+fixed head 4 mm adjust. from h. 53 to 88 mm <i>euro/pc (euro/pack)</i>	19276	24 pcs	672 pcs
XL/84/147/4F	base+screw+fixed head 4 mm adjust. from h. 84 to 147 mm <i>euro/pc (euro/pack)</i>	19277	24 pcs	480 pcs
XXL/145/208/4F	base+screw+fixed head 4 mm adjust. from h. 145 to 208 mm <i>euro/pc (euro/pack)</i>	19280	12 pcs	240 pcs

no partial packaging

PP LEVEL MAXI FIX - BASE + SCREW

ART.		Cod.	Pack	Pallet
S/28/39B	base + screw adjustable from h. 28 to 39 mm <i>euro/pc (euro/pack)</i>	19250	24 pcs	1152 pcs
M/38/57B	base + screw adjustable from h. 38 to 57 mm <i>euro/pc (euro/pack)</i>	19251	24 pcs	1152 pcs
L/56/91B	base + screw adjustable from h. 56 to 91 mm <i>euro/pc (euro/pack)</i>	19252	24 pcs	672 pcs
XL/87/150B	base + screw adjustable from h. 87 to 150 mm <i>euro/pc (euro/pack)</i>	19253	24 pcs	480 pcs
XXL/148/211B	base + screw adjustable from h. 148 to 211 mm <i>euro/pc (euro/pack)</i>	19278	12 pcs	240 pcs

no partial packaging

with fixed head PPLM/T4F the ranges of the bases + screws are to be considered 3 mm lower, therefore the heights will be S: 25 to 36, M: 35 to 54, L: 53 to 88, XL: 84 to 147, XXL: 145 to 208.

EXTENSIONS FOR PP LEVEL MAXI FIX

ART.		Cod.	Pack	Pallet
P1/10	extension h. 10 mm <i>euro/pc (euro/pack)</i>	19369	15 pcs	1800 pcs
P1/80TE	extension h. 80 mm <i>euro/pc (euro/pack)</i>	19254	24 pcs	960 pcs

no partial packaging

Please refer to the extension table on page 12 to view all available height ranges.

PP LEVEL MAXI FIX - FIXED HEAD FOR CERAMIC FLOORS

ART.		Cod.	Pack	Pallet
PPLM/T4F	fixed head for 4-mm joints <i>euro/pc (euro/pack)</i>	19261	48 pcs	3840 pcs

no partial packaging



P1/10



P1/80TE



PPLM/T4F





PP level MINI

PP level SP

PP level MINI

PP LEVEL MINI, LOW-THICKNESS ADJUSTABLE SUPPORTS

PP level MINI is a line of supports for outdoor raised floors, ideal for terraces, pool edges, walkways and other contexts with reduced heights. The range includes the 10/15 model, suitable for self-supporting ceramic, natural stone or concrete slabs with 4-mm joints, the 10/15/TD model for decking floor joists and the 5-mm P/5 extension. The 10/15 and 10/15/TD supports are adjustable from 10 to 15 mm via an integrated ring nut and can be extended up to 30 mm by adding a maximum of three PP level MINI P/5 extensions under the base.



10/15



PP LEVEL MINI

head for 4-mm joints - tabs h. 10 mm

ART.		Cod.	Pack
10/15	adjustable support from h. 10 to 15 mm <i>euro/pc (euro/pack)</i>	19351	20 pcs
10/15/TD	adjustable support from h. 10 to 15 mm - head for decking <i>euro/pc (euro/pack)</i>	19349	20 pcs
P/5	extension h. 5 mm (maximum 3 extensions = +15 mm) <i>euro/pc (euro/pack)</i>	19350	20 pcs

no partial packaging



10/15/TD



P/5

PP LEVEL SP, FIXED-HEIGHT SUPPORTS WITH LOW THICKNESS

SP1 is a **support with fixed height of 14 mm**. It is the simplest and cheapest solution for installing any self-supporting outdoor flooring. According to the conformation of the subfloor, it can be used with with SP2 (1 mm thick) and SP3 (3 mm thick) levellers.



SP1



PP LEVEL SP

ART.	Cod.	Pack	Pallet	
SP1	fixed height support diam. 155x14 h.	19090	360 pcs	5760 pcs

euro/pc (euro/pack)

no partial packaging



SP2

PP LEVEL SP - CORRECTOR FOR SP1

ART.	Cod.	Pack	Pallet	
SP2	corrector for support SP1 thickness 1 mm	19092	1000 pcs	20000 pcs

euro/pc (euro/pack)

SP3	corrector for support SP1 thickness 3 mm	19093	500 pcs	15000 pcs
------------	--	-------	---------	-----------

euro/pc (euro/pack)

no partial packaging

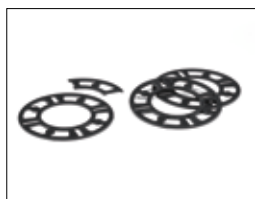

SP3

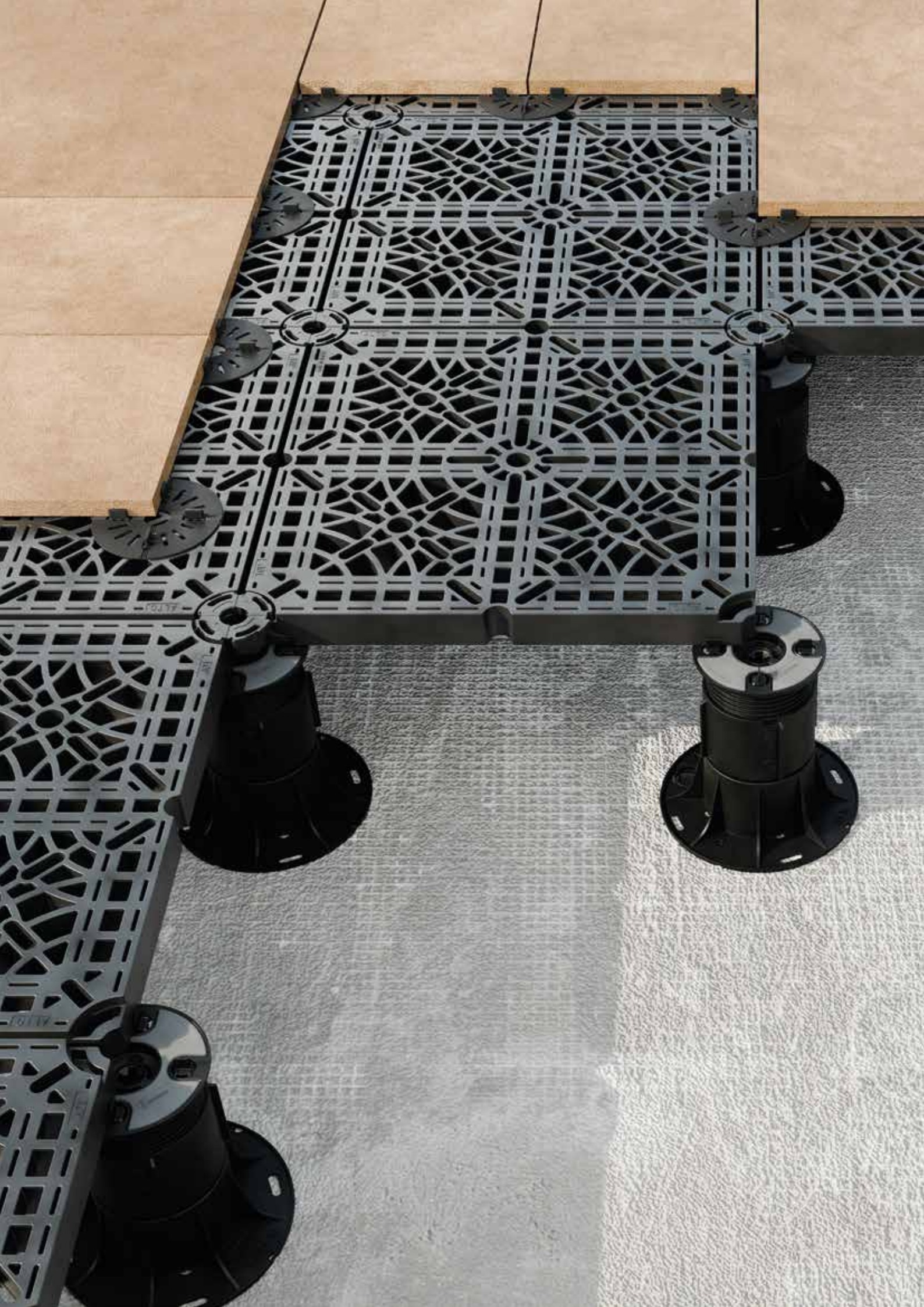



PP level GRID

PP level GRID

PP LEVEL GRID, SAFETY GRID FOR THE INSTALLATION OF MULTI-FORMAT SLABS



PP level GRID is a **safety system** for the installation of outdoor raised floors that creates a solid raised surface on which it is possible to manage the laying of ceramic or stone slabs of different sizes and with different orientations without matching the underlying supports.

The grids are connected to each other through the special locking connector, giving the system **stability and strength**. The result is an **anti-breakdown surface** thanks to which the raised floor remains in place even in the unfortunate event of a slab breaking.





PPL/GRID



PP LEVEL GRID

ART.		cod.	Pallet
PPL/GRID	black polypropylene grid dim. cm 50x50x4 h.	19295	132 pcs

euro/pc (euro/pallet)

no partial packaging



PPL/GRL

ACCESSORIES FOR PP LEVEL GRID

ART.		cod.	Pack	Pallet
PPL/GRL	black polypropylene connector for grid	19296	27 pcs	5832 pcs
PPL/GRD4	black TPV spacer for 4-mm joint	19297	100 pcs	7200 pcs

euro/pc (euro/pallet)

no partial packaging



PPL/GRD4

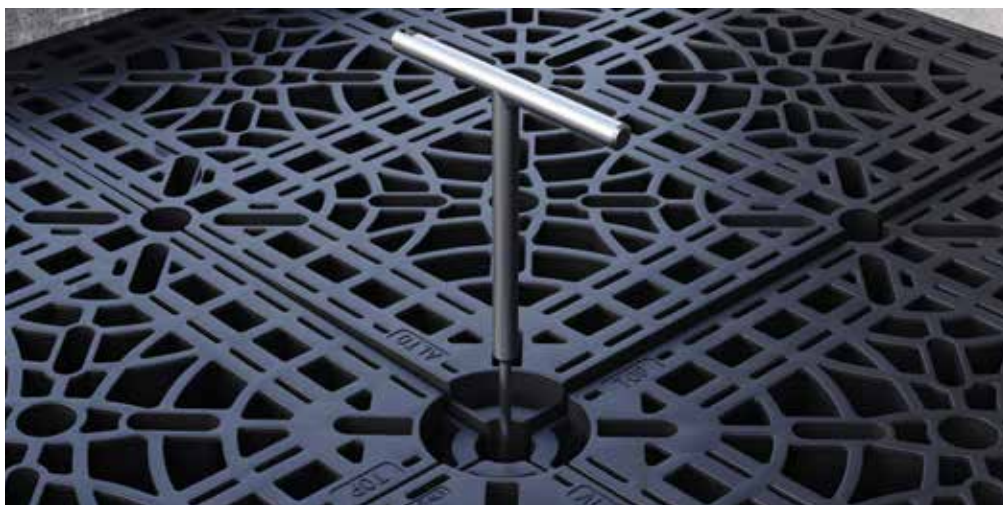

Post-installation adjustment with specific key.



Locking of grid connectors with the connectors themselves.





**complementary
products**

RAISED TILE PROTECTOR



Super hydrophobic treatment with high contact angle, solvent-free, which **significantly reduces water stagnation on outdoor raised floors**. It facilitates water runoff, **reducing stagnation on the surface by over 50%**. Product with very low VOC (Volatile Organic Compound) emissions, with a view to protecting the health of both applicators and end users, EC1 Plus certified.





RTP/1



RAISED TILE PROTECTOR

ART.		Cod.	Pack
RTP/1	Raised Tile Protector 1 Liter	19308	2 pcs
<i>euro/pc (euro/pack)</i>			

no partial packaging

STEP-BY-STEP WATER-REPELLENT TREATMENT



Clean and degrease the surface



Apply Raised Tile Protector



Removal of excess material



Invisible protection with Raised Tile Protector

ADJUSTMENT KEY



Thanks to the special key, PP level DUO MAXI supports with self-levelling head for ceramic floors can be adjusted in height even when the floor is finished, to achieve **perfectly level floors**. For faster adjustment, a steel insert for screwdriver drills is available.

CLIPS FOR VERTICAL CLOSURE



PCC/01

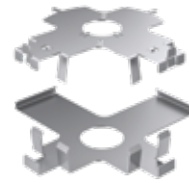

PCC/02



PCC/06
for joist system

PCC/01 and PCC/02 are two stainless steel clip kits (head + base) for **vertical and angular closure** of outdoor raised floors with 20-mm thick tiles.

PCC/06 is the **stainless steel clip** kit (head + base) to be used for **vertical closure** in case of outdoor raised floors with PP level DUO MAXI - Joist system.

PERIMETER SPACERS



PCC/03



PCC/05



PCC/03 and PCC/05 are **two clips, in stainless steel and polypropylene respectively**, both with perimeter spacer function, to obtain uniform and linear joints between the tiles and the perimeter wall.

PERIMETER PROFILES



Protec CPLV-CPLB is a series of **colour-coated aluminium perimeter profiles** for protecting and finishing the outer edges of outdoor raised floors.

RUBBER MAT



PPL/S is a rubber mat with a diameter of 21 cm and a thickness of 2 mm with **anti-noise function**.

LEVELLING DISK FOR HEAD



PPL/DLT is a rubber levelling disk to be placed on the support head to shim one or more sectors and correct **tiles with uneven thicknesses**.

LEVELLING DISK FOR BASE



PPL/DLB is a **rubber levelling disk** to be placed under the support base to shim one or more sectors and **correct any imperfections in the subfloor**.

BATTERY-POWERED VACUUM SUCTION CUP



PPL/V is a **vacuum suction cup with rechargeable battery**, for handling ceramic slabs and with a maximum load capacity of 200 kg.

SLAB LIFTING HANDLE



PPL/MM is an **adjustable slab lifting handle from 39 to 62 cm** for handling and laying ceramic slabs.

TILE LIFTER



PPL/GS is a **tool for lifting already laid slabs** with a minimum joint of 4 mm.



CR/M



accessories for installation

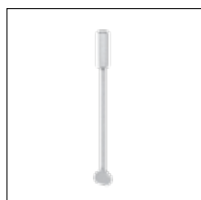

PPL/CT

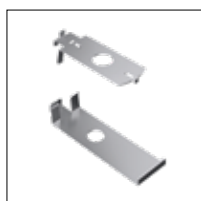

PCC/01

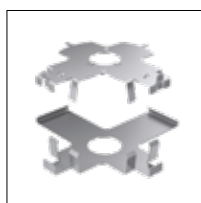

PCC/02



vacuum suction cup



PCC/03



slab lifting handle



PCC/05

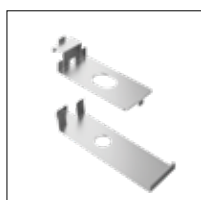

PCC/06

ACCESSORIES FOR INSTALLATION

ART.		Code	Pack
CR/M	adjustment key (for 4 mm joints) <i>euro/pc</i>	19376	12 pcs
PPL/CT	insert for screwdriver drill <i>euro/pc</i>	19306	1 pc
PCC/01	perimeter clip (base + head) <i>euro/kit (euro/pack)</i>	19382	30 kit
PCC/02	corner clip (base + head) <i>euro/kit (euro/pack)</i>	19383	4 kit
PCC/03	wall clip in stainless steel <i>euro/pc (euro/pack)</i>	19384	50 pcs
PCC/05	wall clip in black polypropylene <i>euro/pc (euro/pack)</i>	19377	200 pcs
PCC/06	perimeter clip for joist system (base + head) <i>euro/kit (euro/pack)</i>	19368	30 Kit
PPL/S	rubber mat diam. cm 21 x 0,2 thick. <i>euro/pc (euro/pack)</i>	19385	100 pcs
PPL/DLT	levelling disk for head diam. cm 12 x 0,2 thick. <i>euro/pc (euro/pack)</i>	19378	100 pcs
PPL/DLB	levelling disk for base diam. cm 21 x 0,2 thick. <i>euro/pc (euro/pack)</i>	19379	100 pcs
PPL/V	battery-powered vacuum suction cup <i>euro/pc</i>	19302	1 pc
PPL/MM	slab lifting handle (from 39 to 62 cm) <i>euro/pc</i>	19307	1 pc
PPL/GS	tile lifter for 4 mm joints <i>euro/pc</i>	19305	1 pc

no partial packaging (except for CR/M)



PPL/S



PPL/DLT



PPL/DLB



PPL/V



PPL/MM

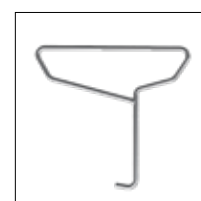

PPL/GS

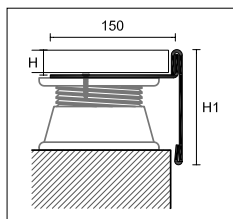

PROTEC

length = 270 cm - pack 10 pcs

H

BASE

ART. finishing

20

ALUMINIUM

CPLB natural aluminium

86900

euro/m

CPLB/2 natural aluminium

86901

euro/m

CPLB with draining holes available on request, extra euro/m 3,52

CPLB and CPLB/2 in 15 and 25 mm height available on request

possibility to choose noise-proof gasket PPL/GM, see page 13

PROTEC

length = 270 cm - pack 10 pcs

H1

FRONTALE

ART. finishing

60

80

100

ALLUMINIO VERNICIATO

ash grey RAL 7038

86902

86904

86906

ancient grey

86903

86905

86907

CPLV/

stone

86908

86909

86910

greige

86911

86912

86913

sand

86914

86915

86916

beige

86917

86918

86919

euro/m

white RAL 9003, dark brown RAL 8019, metal grey RAL 9006, aluminium grey RAL 9007, ash grey RAL 7038 embossed and rust with a minimum of 270 meters, on request, without surcharge. For other colours please contact our sales department.

OUTSIDE CORNER 90°

pack 5 pcs

H1

ART. finishing

60

80

100

ACOLOUR-COATED ALUMINIUM

ash grey RAL 7038

86920

86922

86924

ancient grey

86921

86923

86925

CPLV/ /E

stone

86926

86927

86928

greige

86929

86931

86933

sand

86935

86936

86937

beige

86938

86939

86940

euro/pc

JUNCTION

width = 70 mm - pack 5 pcs

H1

ART. finishing

60

80

100

COLOUR-COATED ALUMINIUM

ash grey RAL 7038

86930

86932

86934

ancient grey

86941

86942

86943

CPLV/ /G

stone

86944

86945

86946

greige

86947

86948

86949

sand

86950

86951

86952

beige

86953

86954

86955

euro/pc

no partial packaging

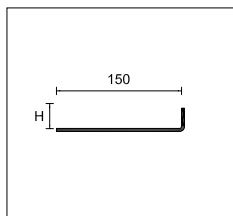

CPLB
base for raised
floors

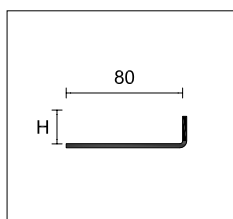

CPLB/2
punched base for
tiled floors

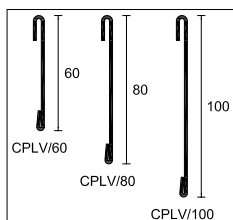

CPLV/

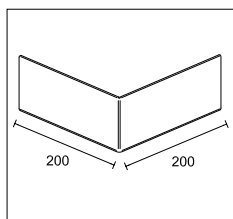

CPLV/ /E

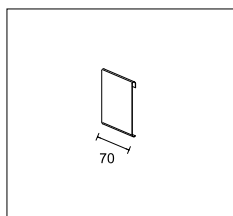

CPLV/ /G



sample box PP level DUO MAXI

00249



sample of PP level DUO MAXI - Joist

00241

sample of PP level DUO MAXI - Joist (drainage joist)

00253



sample case PP level DUO MAXI

00359



sample of PP level GRID

00371



brochure PP level DUO MAXI IT/GB

00299

GENERAL CONDITIONS OF SALE

These General Conditions shall govern all sales contracts executed between Profilpas S.p.A. and the Buyer and shall prevail on all the Buyer's general or individual purchasing conditions. Any derogation to these General Conditions shall be binding on Profilpas only if accepted in writing by the latter.

These General Conditions are understood to be fully known and accepted by the Buyer as they are an integral part of the order confirmations issued by Profilpas; any exceptions must be agreed in writing under penalty of nullity.

1. Prices

The prices shown in Profilpas' price list are in Euros per meter and per piece, depending on the type of product; invoicing is done on a per piece-basis with the discounts applied in accordance with the ordered quantities or upon written agreement with Profilpas. Prices do not include additional taxes or customs duties. Profilpas expressly reserves the right to modify the prices at any time without prior notice, depending on fluctuations in the costs of raw materials, energy and production.

2. Orders

The required minimum order is fixed at the net amount of Euro 500,00. Purchase orders must be submitted in writing. Orders will only be deemed accepted and binding on Profilpas upon the sending of the corresponding order confirmation by the same Profilpas. For orders concerning customised products - i.e. products not included in the catalogue and/or made to the Buyer's specific request - the Buyer accepts a quantity tolerance of +/- 10% with respect to the quantity ordered.

Orders submitted by the Buyer shall be deemed irrevocable for a period of 90 days and shall become binding on Profilpas only upon issuance of the relevant order confirmation.

Should Profilpas proceed with the execution of the order, the sale shall be governed exclusively by these general terms and conditions of sale. If the order confirmation contains amendments to the original order, such amendments will be deemed tacitly accepted by the Buyer after 5 days from receipt of the order confirmation unless the Buyer notifies its disagreement in writing within the above-mentioned term.

3. Transport and delivery terms

Deliveries shall be made according to the Incoterms indicated in the order confirmation. The products shall always be transported at the Buyer's risk regardless to the Incoterms indicated in the order confirmation, and any reimbursements for damages shall be claimed by the Buyer to the carrier in accordance with the relevant agreements and clauses contained in the stipulated insurance policies.

Shipping dates indicated in the order confirmation are estimated and not guaranteed. In the event of a delay in delivery, the Buyer shall not have the right to terminate the sales agreement and/or claim compensation for any direct, indirect or consequential damages, unless there is evidence of Profilpas's willful misconduct or gross negligence.

Profilpas shall not be held liable in any way for delays or failure to perform its obligations due to force majeure events, including but not limited to natural disasters, fires, strikes, wars, pandemics, transportation disruptions, measures imposed by competent authorities, or any other unforeseeable event beyond its control. In such cases, the delivery and/or performance deadlines shall be suspended for the duration of the impediment.

4. Packaging

Prices include Profilpas standard packaging. Any sea shipment packaging or any other special packaging requested by the Buyer will be charged at cost. Profilpas's catalogue indicates which products have partial packaging.

5. Terms of payment

All payments must be made in accordance with the agreed payment terms; the relevant amounts must be transferred to the bank account indicated by Profilpas. In the event of a delay in payment, whether total or partial, the Buyer shall be required to pay interest on all outstanding amounts, calculated in accordance with art. 5 of Italian Legislative Decree no. 231/2002 as amended. Any delay or non-payment of sums owed by the Buyer to Profilpas entitles Profilpas to suspend the preparation and delivery of products ordered and of any other order in progress.

If the Buyer fails to perform its obligations over a prolonged period, Profilpas may terminate any existing contract with immediate effect, without prejudice to any further action to recover credit or claim compensation for damages.

6. Claims

Any complaints relating to the condition of the packaging, the quantity, the number or the external characteristics of the products must, under penalty of forfeiture, be lodged with the carrier upon receipt of the products by means of a note on the transport document and notified to Profilpas in writing within 8 days of the delivery date. If no written complaint is lodged with the carrier at the time of delivery Profilpas will not accept any returns or replacements of the delivered products. Returns will only be accepted upon Profilpas's prior written consent and always at the Buyer's expense.

Profilpas shall not be responsible for any damages to the products that are consequential or subsequent to their installation.

Complaints relating to hidden defects that could not be detected by a thorough inspection at the time of delivery must be reported to Profilpas within 8 days of the defect's discovery and no later than 12 months from the delivery date. Such notification must be sent via registered mail with return receipt and e-mail.

Under no circumstances shall filing complaints or disputes entitle the Buyer to suspend or delay payments due to Profilpas, regardless of whether such payments relate to the disputed products.

7. Retention of title (article 1523 of the Italian Civil Code)

The products shall remain the property of Profilpas until full payment has been received. In the event of non-compliance or partial compliance with the agreed payment terms Profilpas, without prejudice to any other rights or claims, shall be entitled to recover the supplied products. Until ownership is transferred, the Buyer is responsible for the custody of the products, with the diligence of a good custodian, and shall be liable for any damage, loss or deterioration of the products due to poor storage or negligence.

8. Warranty and defects

Profilpas products are intended for professional use and should therefore be installed by qualified and experienced personnel. Any reference to "do-it-yourself" in the catalog is meant only to highlight the ease and speed of installation of the products without altering their professional nature.

Profilpas guarantees that its products are free from defects in material and workmanship for a period of 12 months from the delivery date, provided that they have been promptly notified in accordance with the provisions of the paragraph "Claims".

Should Profilpas acknowledge the existence of the claimed defects, Profilpas's warranty shall be limited, at its discretion, to either: i) the replacement of the defective products, free of charge at Profilpas's premises according to the Incoterms indicated in the order confirmation and within the normal time required therefor, or ii) to the issue of a credit note for the amount of the defective products.

ANY OTHER WARRANTIES, LEGAL OR CONVENTIONAL, AND ANY CLAIMS FOR FURTHER DIRECT, INDIRECT OR CONSEQUENTIAL DAMAGES WHETHER SUSTAINED BY THE BUYER OR THIRD PARTIES, ARE EXPRESSLY EXCLUDED EXCEPT IN CASE OF INTENT, GROSS NEGLIGENCE OR MANDATORY LEGAL REQUIREMENTS.

Profilpas does not guarantee that the products comply with any particular specifications, technical characteristics or suitability for any particular or special uses unless such characteristics are expressly agreed upon in the sales contract.

Profilpas shall not be liable for damages to the products due to inadequate storage, damage resulting from or subsequent to their installation, nor for damage that the Buyer, or third parties having cause from the latter, claim to have suffered following the use of the products except in the case of fraud or gross negligence by Profilpas or in cases of non-derogability provided for by law.

The Buyer expressly waives its right of recourse according to article 134 of the Italian Consumer Code.

9. Industrial and intellectual property

All brands, distinctive signs, designs and product photographs are the property of Profilpas and may not be used without the prior written authorization of Profilpas.

10. Privacy

The parties undertake to comply with the laws on protection and processing of personal data that may apply to the relationships between the parties pursuant to the sales contracts executed, including EU Regulation 2016/679 "General Data Protection Regulation" or "GDPR". The parties also assume the qualification of "data controller" in relation to the personal data acquired in the performance of the agreement.

11. Applicable law and jurisdiction

Sales of Profilpas products are governed by Italian law. Any dispute arising from the interpretation, performance or termination of the sale contracts shall be submitted to the exclusive jurisdiction of the courts of Milan - Italy.

According to Art. 1341 and 1342 of the Italian Civil Code, the Buyer expressly accepts the provisions of Art. 3 (Delivery terms), 5 (Terms of payment), 6 (Claims), 7 (Retention of title), 8 (Warranty and defects) and 11 (Applicable law and jurisdiction).

The Buyer

INDEX BY ITEM

10/15	20
10/15/TD	20
CPLB	31
CPLB/2	31
CPLV/	31
CPLV/ /E	31
CPLV/ /G	31
CR/M	34
L/53/88/4F	17
L/56/91/4	12
L/56/91B	12 - 17
M/35/54/4F	17
M/38/57/4	12
M/38/57B	12 - 17
P/5	20
P1/10	12 - 17
P1/80TE	12 - 17
PCC/01	34
PCC/02	34
PCC/03	34
PCC/05	34
PCC/06	34
PCC/L	13
PPL/5030/T	13
PPL/CT	32
PPL/D4	13
PPL/DLB	34
PPL/DLT	34
PPL/GM200	13
PPL/GM50	13
PPL/GR1	13
PPL/GRD4	25
PPL/GRID	25
PPL/GRL	25
PPL/GS	34
PPL/MM	34
PPL/S	34

PPL/T1	13
PPL/TH	13
PPL/TD/GR	13
PPL/TD/TT	13
PPL/V	32
PPLM/T2	13
PPLM/T3	13
PPLM/T4	13
PPLM/T4F	17
PPLM/TA	13
PPLM/TD	13
RTP/1	28
S/25/36/4F	17
S/28/39/4	12
S/28/39B	12 - 17
SP1	21
SP2	21
SP3	21
XL/84/147/4F	17
XL/87/150/4	12
XL/87/150B	12 - 17
XXL/148/211/4F	12
XXL/148/211/4	12
XXL/148/211B	12 - 17



profilpas.com

Profilpas S.p.A.

Registered office:

Viale E. Jenner, 4
20159 Milano (MI) Italy

Head office and plant:

Via Einstein, 38
35010 Cadoneghe (PD) Italy

Customer Service Italy: +39 049 8878411
Customer Service Export: +39 049 8878412

Technical Support: assistentzatecnica@profilpas.com

info@profilpas.com
profilpas.com